

Flynn STANDARD Air/Gas Mixing Station

DS314A1

Description

The Flynn air/gas mixing station is extremely versatile and is used in a broad range of applications requiring 100% premix, it can be used on any clean gaseous fuel.

The Flynn air/gas mixing station is compact and inexpensive to operate.



Photo Shows One Burner Flame Treating System



1 Burner Flame Treating System

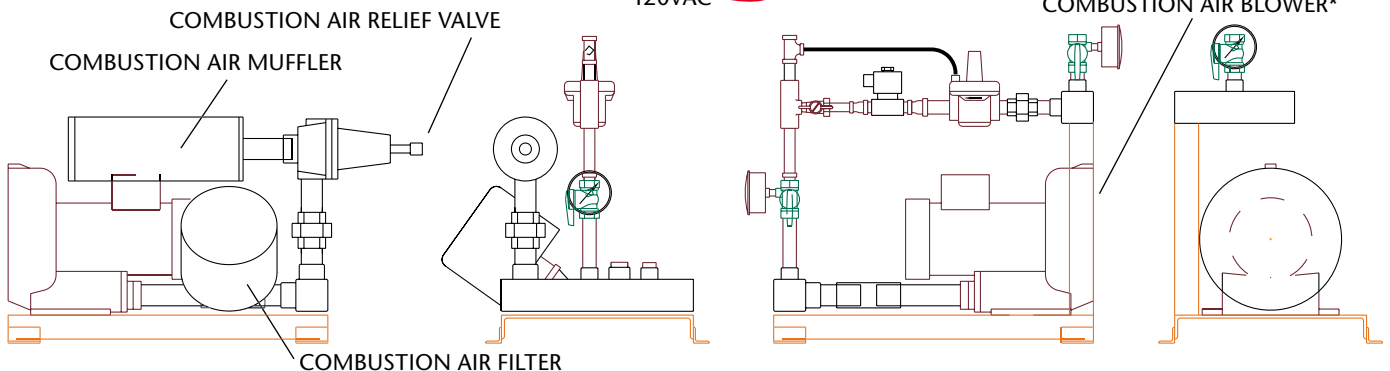
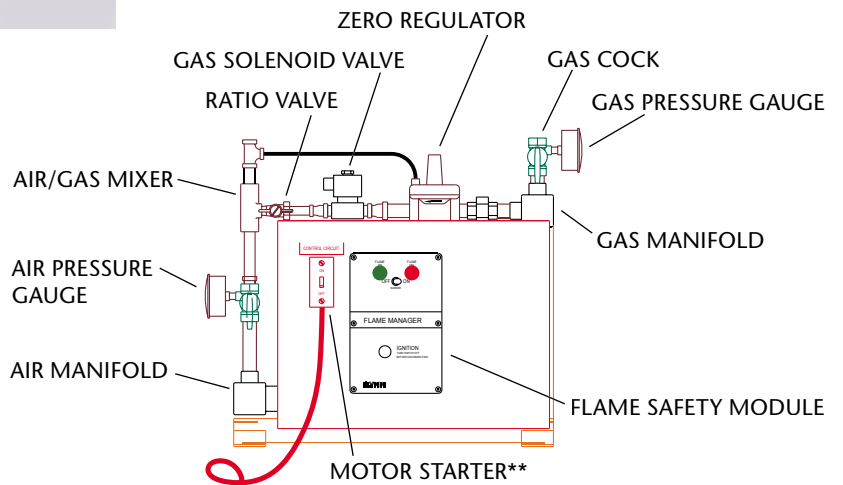

DP. No. 098278

**OTHER VOLTAGES AVAILABLE

*COMPRESSED AIR AVAILABLE

The Flynn STANDARD Surface-Treatment System with #3Fum Unimixer

DS314A2

2 Burner Flame Treating System

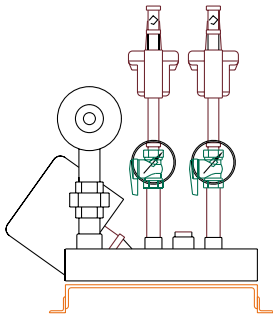

DP. No. 098279

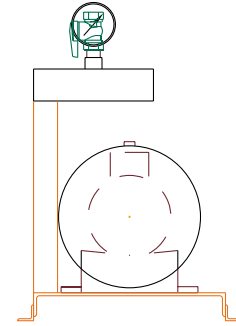
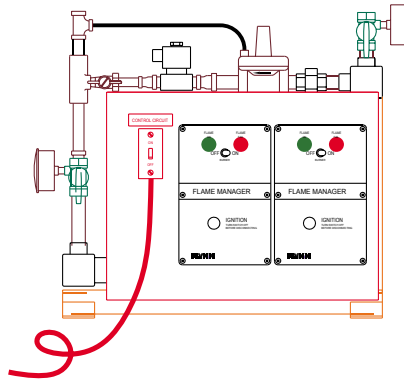

3 Burner Flame Treating System

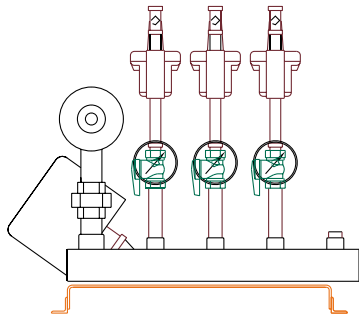

DP. No. 303031

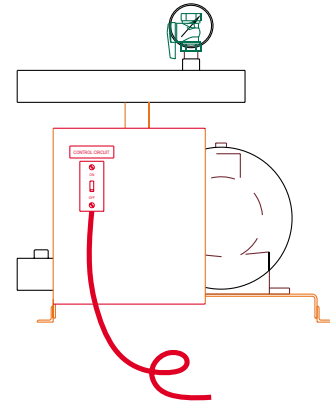
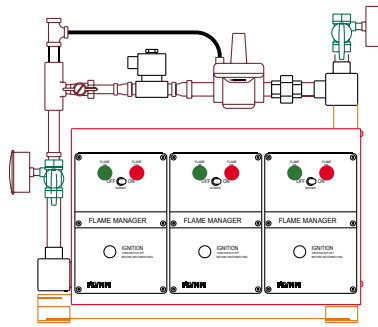

4 Burner Flame Treating System

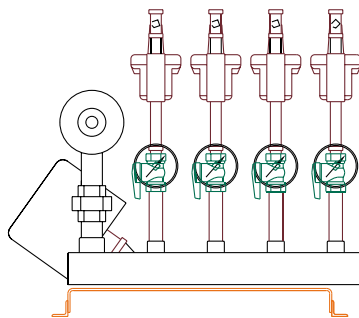

DP. No. 098228

